



PETROLIO ENERGIE INDIA PVT LTD

www.petrolioenergie.com , info@petrolioenergie.com ,

| INDIA | UAE | Egypt | Iraq |

India+91-8637790769, +91-7387690017 | UAE: +971563667973,+971 2 445 3308

About Us

Petrolio Energie India Pvt Ltd. We 'VALUE' our clients by providing Economical, Effective and Efficient engineering solutions. We believe in continuous improvement and aspire to build long term relationships with them.

PEIL commenced operations to provide design and engineering services and tailor made specific solutions to Clients/ Contractors for FEED, Detailed Engineering, Construction Engineering, Technical Deployment of skilled personnel, PMC Services. Our staff Personnel has vast experience in Oil & Gas, Energy, Power, Cross Country Pipeline, LNG & LPG, Storage Tank, Water and Infrastructure, Process Skid Design, Pharma , Food Process plant, Turnkey Solution related projects in India, Iraq, Australia, Egypt, Middle-East, Africa and South East Asia.





PETROLIO ENERGIE INDIA PVT LTD

www.petrolioenergie.com , info@petrolioenergie.com ,

| INDIA | UAE | Egypt | Iraq |

India+91-8637790769, +91-7387690017 |UAE: +971563667973,+971 2 445 3308



Mission

To provide error free engineering services within schedule & cost effective solution.

We strive to achieve our vision through, Deep integrity, Commitment & Ethical code of business.

Developing leadership through result oriented culture. Focus on 100% client satisfaction.

Vision

“A world class organization continuously reinventing itself, committed to reducing energy wastage and carbon footprint, thereby enhancing values to stakeholders, employees, client, society and the humanity at large.”



PETROLIO ENERGIE INDIA PVT LTD

www.petrolioenergie.com , info@petrolioenergie.com ,

| INDIA | UAE | Egypt | Iraq |

India+91-8637790769, +91-7387690017 | UAE: +971563667973,+971 2 445 3308



HSE Statement

Our Health, Safety and Environmental expectations are integral elements of our business. They are embedded into our management systems and processes and influence everything that we do.

In addition, PEIL is increasingly involved in the provision of project and construction management services in several parts of the world.

PEIL will progress towards its vision of zero harm to people, assets and the environment. The fundamental building blocks necessary for us to succeed are already in place. New or improved standards, processes and procedures will help achieve safer and more environmentally friendly outcomes.



PETROLIO ENERGIE INDIA PVT LTD

www.petrolioenergie.com , info@petrolioenergie.com ,

| INDIA | UAE | Egypt | Iraq |

India+91-8637790769, +91-7387690017 | UAE: +971563667973,+971 2 445 3308

Corporate Statement

We realize that project we undertake involve a huge commitment; to our people, to our clients and to the wider community.

We ensure that the Company meets high standards of safety, performance and governance across its global operations. This is an ongoing commitment, requiring continual review, modification and enhancement of governance systems.

The Company recognizes that it has responsibilities to its customers, employees and suppliers as well as to the welfare of the communities in which it operates.

We focus on HSE right from the start of a project until each project is safely and successfully completed. And we expect to achieve the same world-class HSE standards wherever we work in the world.



PETROLIO ENERGIE INDIA PVT LTD

www.petrolioenergie.com , info@petrolioenergie.com ,

| INDIA | UAE | Egypt | Iraq |

India+91-8637790769, +91-7387690017 | UAE: +971563667973,+971 2 445 3308

Services Sectors are



Oil & Gas



Refinery Work



Cross Country



Well Head



Petrochemical



Fertilizer Work



Process Skid

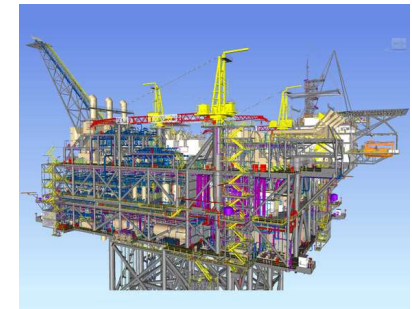

Offshore



PETROLIO ENERGIE INDIA PVT LTD

www.petrolioenergie.com , info@petrolioenergie.com ,

| INDIA | UAE | Egypt | Iraq |

India+91-8637790769, +91-7387690017 | UAE: +971563667973,+971 2 445 3308

Project Management

- Engineering Document Deliverables
- Engineering Execution Plan
- Engineering quality plan
- Home Office IT Plan
- Engineering Organization Chart
- Engineering Document Distribution Matrix
- Engineering Progress Reports
- Engineering project Schedule
- Cost and Schedule Risk Analysis





PETROLIO ENERGIE INDIA PVT LTD

www.petrolioenergie.com , info@petrolioenergie.com ,

| INDIA | UAE | Egypt | Iraq |

India+91-8637790769, +91-7387690017 |UAE: +971563667973,+971 2 445 3308

Process Engineering

- Mass, Heat and Utility Balances
- Process Flow Diagrams (PFDs)
- Piping and Instrument Diagrams (P&IDs)
- Process Data Sheets for Equipment and Systems
- Basis of Design
- Cause and Effect Charts (Plant and Package Units)
- Hydraulic Calculations and Hydraulic study Report
- Utility Consumption Summary
- Instruments and Equipment's Process Data Sheets
- Pre-commissioning and COMMISSIONING Procedures
- Operation and Shutdown Philosophy
- Line & Equipment list
- Tie-In philosophy





PETROLIO ENERGIE INDIA PVT LTD

www.petrolioenergie.com , info@petrolioenergie.com ,

| INDIA | UAE | Egypt | Iraq |

India+91-8637790769, +91-7387690017 |UAE: +971563667973,+971 2 445 3308

Mechanical Engineering

- Basic Design
- Mechanical Equipment Specifications
- Mechanical Calculations
- Mechanical Studies
- Mechanical Equipment List
- Material Selection Diagrams
- HVAC Schematics and Layouts
- Standard Mechanical Detail Drawings
- Equipment Detail Drawings
- Mechanical Datasheets, MTO
- Material Requisition
- Technical Bid Evaluation
- Static and Rotating Equipment
- Plant Equipment





PETROLIO ENERGIE INDIA PVT LTD

www.petrolioenergie.com , info@petrolioenergie.com ,

| INDIA | UAE | Egypt | Iraq |

India+91-8637790769, +91-7387690017 | UAE: +971563667973,+971 2 445 3308

Civil & Structural Engineering

- Geotechnical Surveys
- Structural Design Criteria
- Civil, Structural Calculations
- CSA Studies
- Site Survey Monument Location Plan
- Geotechnical Investigation scope of work
- Topographical Map
- Site Preparation and Rough Grading Drawing
- Composite U/G Drawings
- Final Grading and Paving Drawings
- Foundation Drawings
- Structural Steel Drawings
- Architectural Drawings
- Standard Civil, Structural & Architectural Det
- 3D CADD C/S/A Model





PETROLIO ENERGIE INDIA PVT LTD

www.petrolioenergie.com , info@petrolioenergie.com ,

| INDIA | UAE | Egypt | Iraq |

India+91-8637790769, +91-7387690017 |UAE: +971563667973,+971 2 445 3308

Piping Engineering

- Basis Design
- Piping Material Specification
- Piping Datasheets (Pipe Supports, Spring Hangers, etc)
- Standard Piping Support Drawing Index
- Special Pipe Support Drawings Index
- 3D CADD Piping Model
- Pipe and Fittings Material Take-Off (MTO)
- Valve Material Take-Off (MTO)
- Vessel Nozzle and Platform Orientation Drawing
- Piping Standard Detail Drawings
- Pipe Support Standard Drawings
- Special Pipe Support and Spring Support Drawings
- Miscellaneous Piping Detail Drawings
- Piping Isometric Drawings
- Material Requisition (pipe, valve, fittings, SP Items, etc.)
- Technical Bid Evaluation
- Stress Analysis





PETROLIO ENERGIE INDIA PVT LTD

www.petrolioenergie.com , info@petrolioenergie.com ,

| INDIA | UAE | Egypt | Iraq |

India+91-8637790769, +91-7387690017 | UAE: +971563667973,+971 2 445 3308

Pipeline Engineering

- Pipeline Design & Calculations
- Pipeline Specifications & Pigging Philosophy.
- Hot Tap Design Calculation Report
- Pipeline Schematic Diagram
- Pipeline Key Plan & Alignment Sheets
- Pipeline Crossing drawings
- Typical Pipeline Construction Drawings
- Pipeline Overall Route Maps
- Pipeline town planning approval maps
- Pipeline Station Approach drawings
- Plot Plans and Piping General Arrangement drawings for SV Station, Scraper launcher/receiver facilities and interconnections.
- Piping Isometrics
- Material Requisitions (Line pipes, valves, bends, isolating joints, barred tees, anchor flanges, scraper launcher/receiver traps, split tees ...etc.)
- Technical Bid Evaluation Reports (Line pipes, valves, bends, isolating joints, barred tees, anchor flanges, scraper launcher/receiver traps, split tees ...etc.)





PETROLIO ENERGIE INDIA PVT LTD

www.petrolioenergie.com , info@petrolioenergie.com ,

| INDIA | UAE | Egypt | Iraq |

India+91-8637790769, +91-7387690017 | UAE: +971563667973,+971 2 445 3308

Well Head & Well Pad Engineering

Engineering & Design for Well Head / Well Pad

- Well head PFD & P&IDS
- Low pressure Separation
- Production Manifold
- Metering Skid
- Test Manifold
- Hot Injection Water Manifold
- Production fluid Pig Luncher / Receiver for Well Pad
- Solar Power
- Hydraulic Packages
- Chemical Injection skid

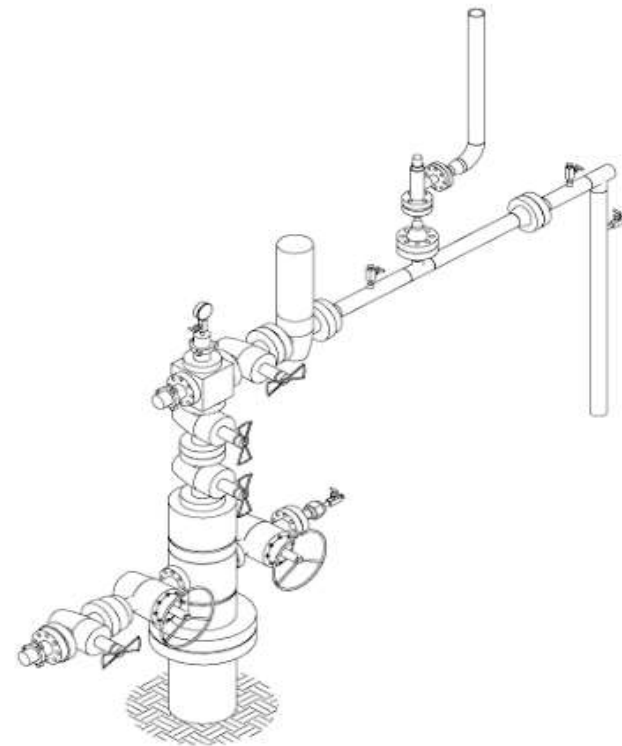



PETROLIO ENERGIE INDIA PVT LTD

www.petrolioenergie.com , info@petrolioenergie.com ,
INDIA | UAE | Egypt | Iraq

India+91-8637790769, +91-7387690017 | UAE: +971563667973,+971 2 445 3308

HVAC Engineering

- Design Criteria for HVAC System Design
- Design Load Calculations
- Selection of HVAC System
- Sizing of Equipment
- Project Specification for HVAC System
- Data Sheets (HVAC Equipment)
- Duct, pipe and Instrumentation Diagrams
- Specification for Performance Testing (FAT / SAT)
- Material approval requisition for HVAC equipment and materials.
- Static head calculations.
- Control schematics.
- HVAC and piping layouts.
- Ductwork and piping builders work penetrations.
- Duct and piping support.
- General notes and detail standards.
- ITP for HVAC equipment/materials.
- Method statement for HVAC services installation.
- Pre-commission and commissioning for HVAC equipment.





PETROLIO ENERGIE INDIA PVT LTD

www.petrolioenergie.com , info@petrolioenergie.com ,

| INDIA | UAE | Egypt | Iraq |

India+91-8637790769, +91-7387690017 | UAE: +971563667973,+971 2 445 3308

Instrumentation & Control Engineering , Automation

- Instrumentation, Controls, Automation Design Studies
- Instrument Index & Database
- I/O List & Allocation Table
- Cause & Effect Diagram / Shutdown Key
- Alarm & Shutdown Setting Summary
- Process Logic & Complex Control Narrative
- Instrumentation, Controls, Automation Drawings
- Control System Architecture Drawings
- Communication Network Layout Drawings
- RIB / MCC Building Layout
- Instrument Location Drawings
- Instrument Loop Diagrams
- Marshalling / Control Panel / Cabinet Layout
- Junction Box / Panel Layout / Wiring Drawing
- Gas Detection System Layout Drawings
- Fire Alarm System Layout Drawings
- Control Room Layout / Analyzer Shelter Layout
- Standard Instrumentation Installation Detail
- 3D CADD Instrumentation, Controls, Automation Module
- Bulk Instrumentation, Controls, Automation Material
- Instrumentation, Controls, Automation Datasheets
- Material Requisitions
- Technical Bid Evaluation





PETROLIO ENERGIE INDIA PVT LTD

www.petrolioenergie.com , info@petrolioenergie.com ,

INDIA | UAE | Egypt | Iraq

India+91-8637790769, +91-7387690017 | UAE: +971563667973,+971 2 445 3308

Telecommunication Engineering

(CCTV, LDS, SDH, PAGA, Telephones, Structured Cabling, Radio System, Access Control Systems etc.)

- Telecommunication Scope Of Work
- Telecommunications Philosophy
- SPECIFICATIONS and data Sheets for Telecommunications systems
- Bandwidth Calculation report for SDH system
- Telecommunication equipment list
- Telecommunication Index (tagged items)
- Lists of recommended test instruments for maintenance & operation
- Link budget and design report for fiber optic Cable
- Utility schedule for Telecommunications (power requirements)
- Heat dissipation calculations for Telecommunications
- Systems Block Diagrams
- Interconnection drawings
- Termination Diagrams
- Jumpering / termination schedules (fiber and copper)
- Cable and Drum schedule for Telecommunications
- CCTV Coverage Study Report
- PA system noise and Coverage report
- BOQs
- FAT /SAT Procedures

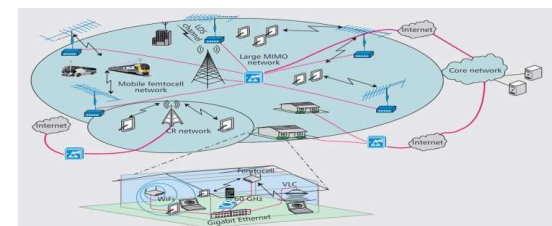



PETROLIO ENERGIE INDIA PVT LTD

www.petrolioenergie.com , info@petrolioenergie.com ,
| INDIA | UAE | Egypt | Iraq |

India+91-8637790769, +91-7387690017 |UAE: +971563667973,+971 2 445 3308

Electrical Engineering

- Electrical Design Criteria
- Standards and Specifications
- Electrical Calculations & Studies
- Electrical Equipment List
- Area Classification Data Sheet Records
- Indices and Lists
- Cable Schedule
- EHT Schedule
- Electrical Load Lists
- Lighting Panel Schedule
- Electrical and EHT Drawings
- Electrical Key Plan
- EHT Key Plan
- Area Classification Drawings
- Single Line Diagrams
- Electrical Equipment and Building Layout
- Motor Control Schematics
- Power and Control Layout Drawings
- Lighting Layout Drawings
- Grounding Layout Drawing
- EHT Power Layout Drawings
- Electrical Heat Tracing Isometrics
- CCTV System Layout Drawings





PETROLIO ENERGIE INDIA PVT LTD

www.petrolioenergie.com , info@petrolioenergie.com ,

INDIA | UAE | Egypt | Iraq

India+91-8637790769, +91-7387690017 | UAE: +971563667973,+971 2 445 3308

Offshore Engineering

Project Engineering:

Front End Engineering & Design (FEED) study

- Development of Piping and Instrument Diagrams and control philosophy
- Preparation of project equipment specifications
- Preparation of process and mechanical datasheets for equipment
- Preparation of major instrument & electrical datasheets such as multiphase flow-meters, Choke valves, emergency shutdown valves and switchboards
- Development of Plant Layout, including equipment location, pipe routings, walkways, escapeways, buildings and room layouts
- Offshore structural design of the topsides and substructure, if applicable
- Design reviews including HAZID, ENVID, HAZOP, RAM, Constructability and others as necessary
- Procurement activities for major equipment items and Long Lead Items to enable order placement.





PETROLIO ENERGIE INDIA PVT LTD

www.petrolioenergie.com , info@petrolioenergie.com ,

INDIA | UAE | Egypt | Iraq

India+91-8637790769, +91-7387690017 | UAE: +971563667973,+971 2 445 3308

Offshore Engineering

Design & Detailed Engineering

- Finalization of Piping and Instrument Diagrams for construction release
- Preparation of piping isometrics for construction including stress analysis
- Preparation of power and control deliverables, including power distribution and control systems for construction
- Preparation of civil/structural (as required) construction drawings
- Procurement of all equipment items
- Development of commissioning and operating documents
- Technical safety support to the project design to ensure safety in design.

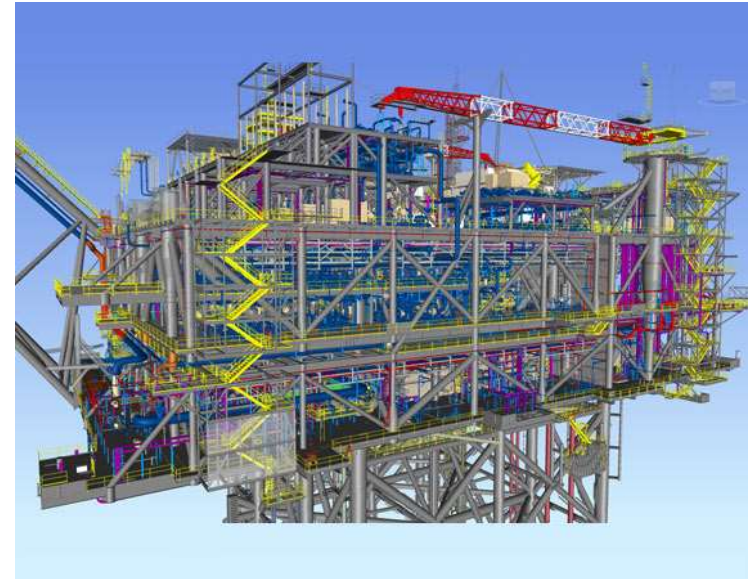



PETROLIO ENERGIE INDIA PVT LTD

www.petrolioenergie.com , info@petrolioenergie.com ,

INDIA | UAE | Egypt | Iraq

India+91-8637790769, +91-7387690017 | UAE: +971563667973,+971 2 445 3308

Offshore Engineering

Structural Engineering

Capabilities:

- Design and engineering of offshore platforms, jackets and top-sides
- Design, engineering and analysis of skids and modular structures
- Stress and fatigue analysis of structures using finite element analysis
- Design documentation (GA/ fabrication drawings, material specifications, procedures, manuals etc.)
- 3rd party verification

Tools:

- PDMS, STAAD-Pro, SESAM, SACS, ANSYS, MATHCAD, In house developed and validated programs

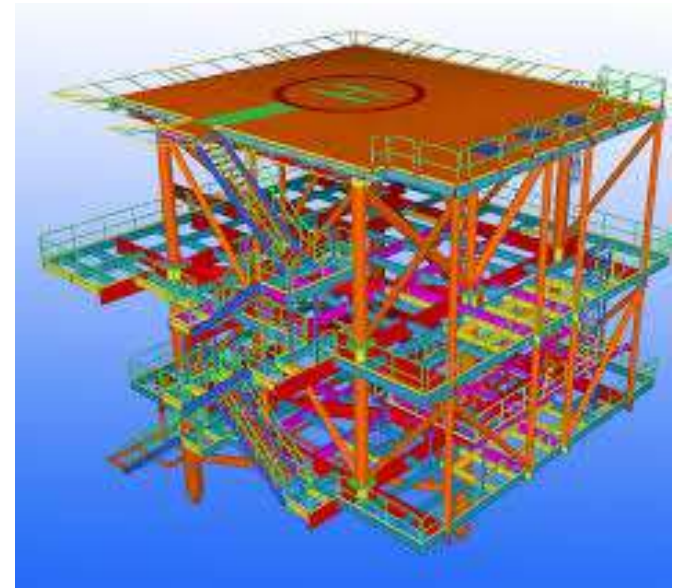



PETROLIO ENERGIE INDIA PVT LTD

www.petrolioenergie.com , info@petrolioenergie.com ,

INDIA | UAE | Egypt | Iraq

India+91-8637790769, +91-7387690017 | UAE: +971563667973,+971 2 445 3308

Offshore Engineering

Process Engineering

Capabilities:

- Equipment sizing and calculations
- Simulation and basic engineering for process units
- Design of process packages for Oil & Gas applications
- Heat and mass balance, generation of PFD and P&IDs
- Specification for various equipment and package systems
- Design of plant hydraulics and pumping system
- Process Design of distillation columns, separators, KO drums
- Heat exchanger thermal sizing and flow induced vibration analysis
- Pipeline surge and slug flow analysis

Tools:

HTRI, HYSYS, FLARENET, PIPESIM, MATHCAD, In house developed and validated program

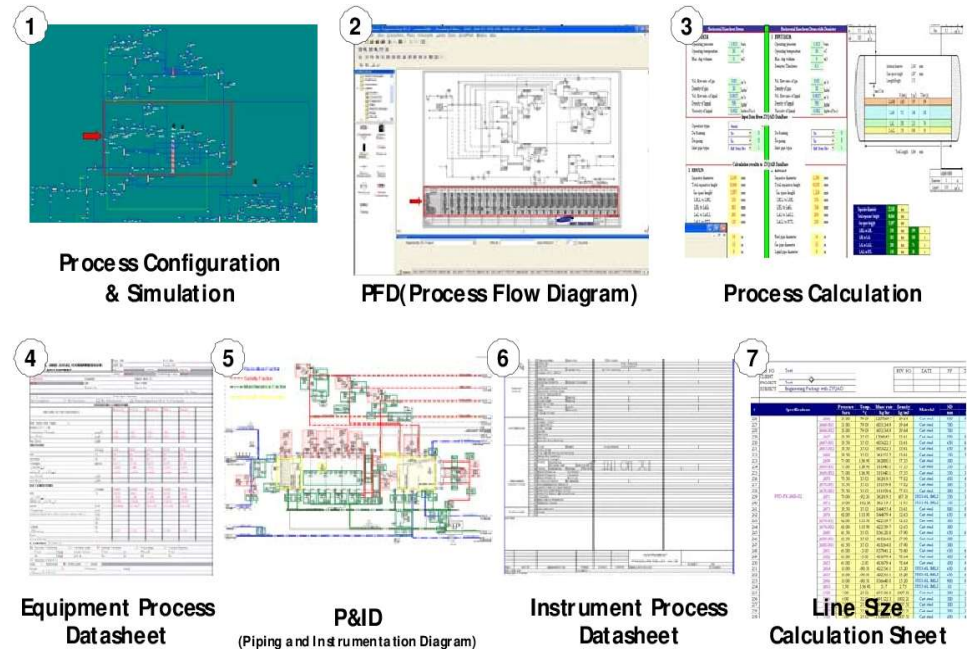



PETROLIO ENERGIE INDIA PVT LTD

www.petrolioenergie.com , info@petrolioenergie.com ,

INDIA | UAE | Egypt | Iraq

India+91-8637790769, +91-7387690017 | UAE: +971563667973,+971 2 445 3308

Offshore Engineering

Piping Engineering

Capabilities:

- 2D drafting and 3D pipe design and layout
- Design documentation (equipment/ isometric/ detail/ GA drawings, MTOs, material specifications etc.)
- Pipe support design
- Pipe stress analysis (static and dynamic)
- Preparation of nozzle orientation and support requirement drawings
- Preparation of technical specifications for piping and specialty items
- Preparation of material take off / requisition for piping and specialty items
- Design optimization and review
- Expert witness/ 3rd party verification work

Tools:

PDMS, SP3D, AutoCAD Plant 3D, Cadworx, Caesar II, MATHCAD, In house developed and validated programs





PETROLIO ENERGIE INDIA PVT LTD

www.petrolioenergie.com , info@petrolioenergie.com ,

INDIA | UAE | Egypt | Iraq

India+91-8637790769, +91-7387690017 | UAE: +971563667973,+971 2 445 3308

Offshore Engineering

Finite Element Analysis

Capabilities:

- Finite Element Analysis
- Linear static
- Non-linear static (Geometric, material and contact)
- Thermal analysis (Steady state and transient)
- Coupled field analysis (Thermal to structural)
- Buckling analysis
- Modal analysis
- Explicit dynamic (Dropped object analysis)
- Fatigue analysis
- Failure analysis
- Residual life evaluation using fracture mechanics
- Computational fluid dynamics (CFD)
- Vibration analysis and studies
- Torsional analysis

Tools:

Ansys, Abaqus, MSc Nastran, Fluent, Ansys CFXI, MATHCAD, In house developed and validated programs

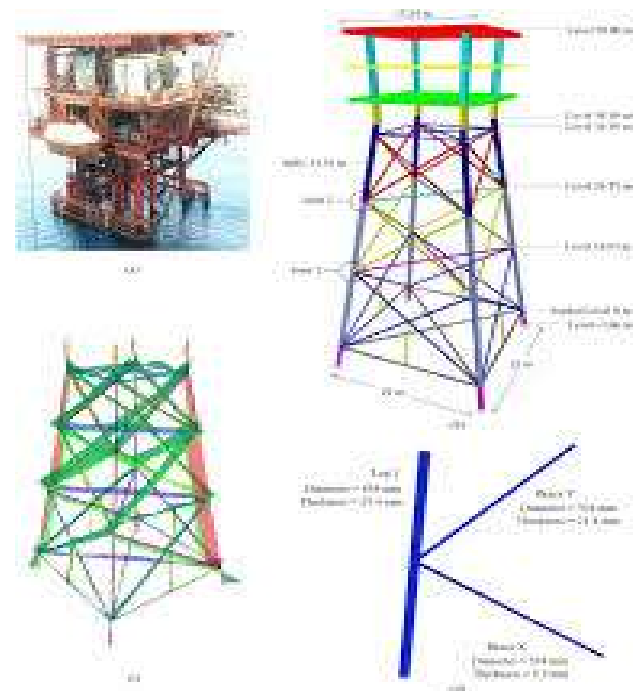



PETROLIO ENERGIE INDIA PVT LTD

www.petrolioenergie.com , info@petrolioenergie.com ,

INDIA | UAE | Egypt | Iraq

India+91-8637790769, +91-7387690017 | UAE: +971563667973,+971 2 445 3308

Offshore Engineering

Mechanical Equipment

Capabilities:

- Pressure Vessels
- Storage Tanks
- Heat Exchangers

Tools:

PV Elite, VVD, HTRI, MATHCAD, In house developed and validated programs





PETROLIO ENERGIE INDIA PVT LTD

www.petrolioenergie.com , info@petrolioenergie.com ,

INDIA | UAE | Egypt | Iraq

India+91-8637790769, +91-7387690017 | UAE: +971563667973,+971 2 445 3308

Offshore Engineering

Elect./Inst. Controls Engineering

Capabilities:

- System control diagrams
- System block diagrams
- Functional descriptions
- Interlock diagrams
- Cause & effect diagrams/ charts
- Sequence diagrams
- Loop drawings
- System & sub-system P&ID
- Equipment/instrument data sheets
- Signal lists
- I/O lists
- Interconnection & wiring diagrams
- Circuit & electrical schematics
- Electrical indexes
- JB and cable schedule
- Layout for instrument/ JB/ cable trays for field & control room
- Installation, mounting and hook up drawings
- Sizing of relief valve/ control valve/ orifice plate

Tools:
INTOOLS

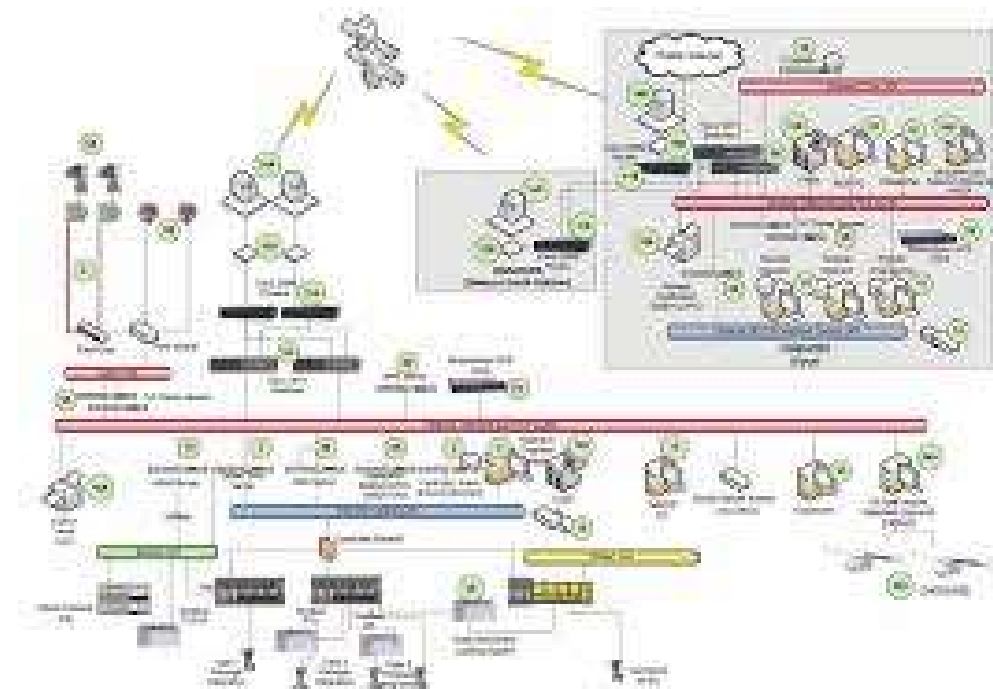



PETROLIO ENERGIE INDIA PVT LTD

www.petrolioenergie.com , info@petrolioenergie.com ,

INDIA | UAE | Egypt | Iraq

India+91-8637790769, +91-7387690017 | UAE: +971563667973,+971 2 445 3308

List of Skid Packages

Complete engineering and design of skids can be undertaken.

- Gas Metering Skids with filtration, metering and pressure reducing stations.
- Oil Metering Skid (Custody Meter with associated equipments) Pressure Safety Valve Sizing, Flare network (including inlet/tail pipe/sub- header/main header sizing etc)
- Flare System Package Skid (Cold Vent Stack or Regular Fuel Fired Flare Stack)
- Flare KOD Package Skid
- Two Phase/Three Phase Separator Skids
- Fuel Gas Conditioning System Skid
- Natural Gas Polishing Unit Skid
- Natural Gas Dehydration Skid (Liquid (TEG) type)
- Natural Gas Dehydration Skid (Molecular Sieve Dehydration type)
- Acid Gas Removal Skid (Amine System)
- Sour Water Stripping Skid (With water or steam stripping)
- Chemical Injection Skid
- Shell and Tube Heat Exchanger Design using software
- Amine Regeneration Skid
- Process Gas Compression Skid
- Lube Oil Console Skid
- Crude Oil Desalter/Dehydrator Skid (Functional Package Specification)
- Crude Oil Emulsion Treater Skid (Functional Package Specification)
- Process Simulations for Packages





PETROLIO ENERGIE INDIA PVT LTD

www.petrolioenergie.com , info@petrolioenergie.com ,

INDIA | UAE | Egypt | Iraq

India+91-8637790769, +91-7387690017 | UAE: +971563667973,+971 2 445 3308

Fire Fitting Engineering

- Safety Design Philosophy
- P & ID for Fire Water Ring Main
- Fire Fighting Equipment Layout
- Fire Fighting Equipment List / Requisitions
- Fire & Gas Cause & Effects Matrix.
- Fire and Gas Detection Equipment Schedule
- Extinguishing Systems Design (Where/if applicable) of fixed fire extinguishing systems (e.g. foam, carbon dioxide, clean agent, and/or dry Powder systems)
- Mobile Fire Fighting Equipment Schedule
- Safety Equipment Schedule





PETROLIO ENERGIE INDIA PVT LTD

www.petrolioenergie.com , info@petrolioenergie.com ,

| INDIA | UAE | Egypt | Iraq |

India+91-8637790769, +91-7387690017 | UAE: +971563667973,+971 2 445 3308

Engineering Software Services

Process:

- Process Simulation System / Physical Properties-HYSYS/ProMax
- Process Hazards Analysis- LIHOU Hazop
- Column hydraulic rating software - K.G. TOWER
- Intelligent P&ID Development- SMARTPLANT P&ID

Piping:

- PDMS
- PDS
- SP3D
- AUTOCAD
- Microstation
- CEASAR-II
- Spoolgen

Mechanical :

- PV Elide
- Tank
- Heat Exchanger Thermal Design -HTRI Xchanger Suite
- Plate Exchangers-HTFS/APLE

Civil & Structural:

- STAAD Pro
- TEKLA

Pipeline:

- Pipeline stress analysis-AUTOPIPE
- GIS- ARCVIEW



PETROLIO ENERGIE INDIA PVT LTD

www.petrolioenergie.com , info@petrolioenergie.com ,

| INDIA | UAE | Egypt | Iraq |

India+91-8637790769, +91-7387690017 | UAE: +971563667973,+971 2 445 3308

Technical Manpower, Contract staffing & Secondment

Deployment of Technical Manpower

We offer our clients with well experienced technical personnel for both long term and short term projects all over the world.

Dedicated Design Engineering Centers

PEIL's Engineering Services outsourcing business model provides Dedicated Design Engineering Centers in its India office to support global customer requirements in a cost- effective manner.



PETROLIO ENERGIE INDIA PVT LTD

www.petrolioenergie.com , info@petrolioenergie.com ,

| INDIA | UAE | Egypt | Iraq |

India+91-8637790769, +91-7387690017 | UAE: +971563667973,+971 2 445 3308

Our Associate Companies





PETROLIO ENERGIE INDIA PVT LTD

www.petrolioenergie.com , info@petrolioenergie.com ,

| INDIA | UAE | Egypt | Iraq |

India+91-8637790769, +91-7387690017 |UAE: +971563667973,+971 2 445 3308

Our Offices Locations

INDIA

Erandavana, Nal Stop, Karve Road , Pune, 411004

Indian :+91-8637790769,+91-7387690017

IRAQ

Kurdistan, Erbil,

Golan st., Front Roj school

UAE

Office 210, Al Khazna Tower, Najda Street Abu Dhabi

UAE:+971-56366797, +971 2 445 3308

EGYPT

19 Gamal Al Din Al Shayal street, 07th district, Al Hadiqah Ad dawleyah, Nasr city, Cairo.

EMAIL ADDRESS

info@petrolioenergie.com

enquiry@petrolioenergie.com
www.petrolioenergie.com

